

99294

Dimensions

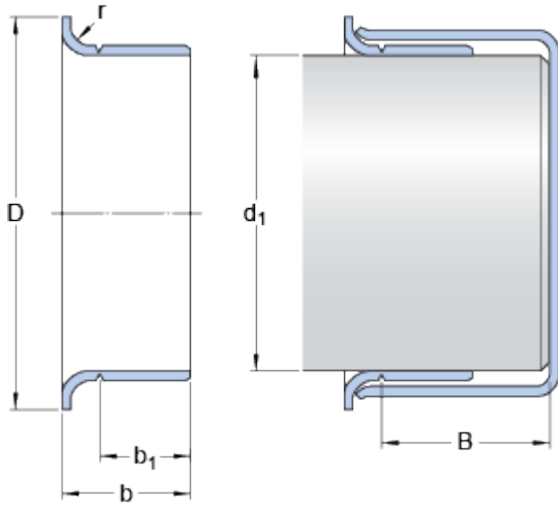

Nominal dimensions

d_1		75	mm
D		83.947	mm
Tolerance outside diameter D	\pm	1.6	mm
b		26.01	mm
Tolerance width b	\pm	0.8	mm
b_1		21.996	mm
Tolerance width b_1	\pm	0.8	mm
B	max.	33.35	mm
r	max.	3.18	mm

Shaft diameter range

d_1	min.	74.93	mm
d_1	max.	75.108	mm